

TIPOS SOLERA

Peraltes		
ESPESOR SOLERA		
	(IN)	(MM)
(MIN)	1	25.4
(MAX)	5	127

Peraltes		
ESPESOR SOLERA		
	(IN)	(MM)
(MIN)	1/4	6.35
(MAX)	3/8	9.525

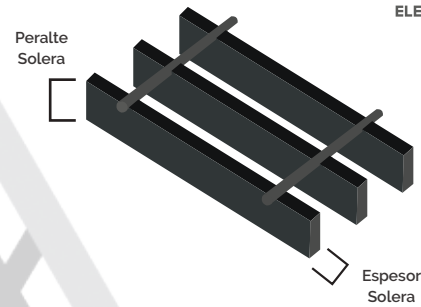







Acabados de Panel

- Natural:** Solera y redondo sin recubrimiento.
- Pintado:** Recubrimiento de base agua.
- Galvanizado:** En base a norma ASTM A-123

CLAROS MÁXIMOS

Tabla informativa para tipo W19-100, W19-50

TIPO DE SOLERAS														
	250 kg/ cm ²		250 kg/ cm ²		150 kg/ cm ²		Tráfico de autos	5 Ton montacargas		3 Ton montacargas		1 Ton montacargas		
	(pulg)	(mm)	(pulg)	(mm)	(pulg)	(mm)	(pulg)	(mm)	(pulg)	(mm)	(pulg)	(mm)	(pulg)	(mm)
1 x 1/4	12	304	10	254	9	228	12	304	7	117	6	152	7	177
1 x 3/8	14	355	13	330	11	279	16	406	9	228	8	203	9	228
1 1/4 x 1/4	15	381	13	330	12	304	17	431	9	228	8	203	10	254
1 1/4 x 3/8	18	457	16	406	14	355	23	584	12	304	10	254	154	355
1 1/2 x 1/4	18	457	16	406	14	457	23	584	11	279	10	254	13	330
1 1/2 x 3/8	22	558	20	508	18	431	30	762	14	355	13	330	19	428
1 3/4 x 1/4	21	533	19	482	17	533	29	736	14	355	12	304	17	431
1 3/4 x 3/8	26	660	23	584	21	584	38	965	18	457	17	431	25	635
2 x 1/4	24	609	22	558	20	508	37	939	16	406	15	381	22	558
2 x 3/8	30	762	28	711	26	660	46	1168	22	558	21	533	33	838
2 1/4 x 1/4	27	685	25	635	23	584	45	1143	19	482	18	457	28	711
2 1/4 x 3/8	34	863	32	812	31	787	53	1346	26	660	26	660	41	1041
2 1/2 x 1/4	30	762	28	711	27	685	52	1320	22	558	22	558	34	863
2 1/2 x 3/8	40	1016	38	965	36	914	59	1498	31	787	31	787	50	1270
3 x 1/4	39	990	37	939	35	889	62	1574	30	762	30	762	49	1244
3 x 3/8	52	1320	50	1270	49	1244	71	1803	43	1092	44	1117	61	1549
3 1/2 x 1/4	48	1219	46	1168	45	1143	72	1828	39	990	40	1016	62	1574
3 1/2 x 3/8	60	1524	60	1524	60	1524	83	2108	56	1422	58	1473	71	1803
4 x 1/4	59	1498	58	1473	57	1447	83	2108	50	1270	51	1295	71	1803
4 x 3/8	68	1727	68	1727	69	1752	95	2413	66	1676	68	1727	81	2057
4 1/2 x 1/4	69	175	69	1752	70	1778	96	2438	61	1549	64	1625	82	2082
4 1/2 x 3/8	71	21803	71	1803	72	1828	96	2438	69	1752	71	1803	84	2133
5 x 1/4	75	1905	75	1905	75	1905	96	2438	72	1828	74	1879	89	2260
5 x 3/8	85	2159	85	2159	86	2184	96	2438	83	2108	85	2159	96	2438